



WSD02-TT1K
User Manual

Capetti
ELETTRONICA

WSD02-TT1K



General warnings.

- The following information must be read and understood before proceeding with the installation, commissioning and maintenance of the devices described in this document.
- **ATTENTION!** Any omission or failure to follow these instructions scrupulously can cause danger.
- **ATTENTION!** Explosion hazard. In case of batteries substitution, make sure that the type is compatible and complies with the specifications indicated by the manufacturer.
- In case of batteries substitution, **DO NOT** disconnect the flat cable which connect the electronic boards without removing batteries before
- ALWAYS substitute all the batteries, also in case of one single battery exhausted.
- If the device is powered by a fixed network, make sure you have disconnected the power supply before carrying out any type of intervention. Failure to comply with this indication can cause damage to people and/or property.
- Follow the manufacturer's suggested warm-up time (*time required to obtain a reliable measurement*) of the transducer.
- Follow the manufacturer's suggested electric wiring of the transducer to measure (*ground shields at a single point, cable length and section*); voltage measures on distances exceed 15/20 meters are subjected to electromagnetic disturbances. 0÷25mA inputs have a superior electromagnetic compatibility (*EMC*).
- Avoid passage in cavities with power or high voltage cables.
- The protection and safety measures and the warranty provided by the Manufacturer with the equipment may be compromised if it's used in a manner that does not comply with this user manual.
- This equipment complies with CE regulations.
- Modifications or tampering not expressly approved by the Manufacturer could void the user's authorization to operate the equipment.
- This equipment must be installed by qualified personnel and in accordance with national regulations and/or related local requirements.
- Make sure that the object is properly fixed to supports/infrastructures capable of withstanding this load. Make sure proper methods and materials are used when fixing the equipment to a wall.
- Only personnel expressly authorized by the manufacturer can open the container. There are no user serviceable parts inside.



1. Description.

The **WSD02-TT1K** is a datalogger with 2 input channels for PT1000 transducer (stamp shape), with storage functionality of samples acquired.

2. Device pre-set and use mode.

a. Wireless Mode:

In this use mode, the datalogger records and transmits each measure sampled to the linked gateway. Typically, the monitoring system is configured in factory, so, if the device is already associated to the system gateway is in **STANDBY** mode (refer to [Picture 5 - Status table – Wireless mode](#)). In this case, it is necessary to start it with the **TEST** command (refer to [Picture 4 – Wireless devices user interface](#)). After this operation, the datalogger reactivates, resumes measure activity, and performs the connection to the gateway or to a *repeater* **WR12**. Connection The onboard LED shows the radio signal quality for 2 minutes (refer to [Picture 5 - Status table – Wireless mode](#)).

Otherwise, in case the device is in **FACTORY RESET** mode (refer to [Picture 5 - Status table – Wireless mode](#)), that means it's ready for connecting to an existing system, in order to associate it using the **ENROL** command. Refer to the "[WineCap System - User Manual R31](#)" software manual. It is necessary to use the [WineCapManager](#) software on the PC connected to the gateway that will be linked with the device.

b. USB Logger Mode:

For this operation mode, the dataloggers works in stand-alone, recording data in its internal memory and without any wireless connection. This is not the factory setup so, to select it, the connection with the PC and the [WineCapManager](#) running on it is necessary to modify the device 's operation mode. The device must be set in **STAND-ALONE** (refer to [7 - Stand-alone USB datalogger installation.](#)) mode and the sample time must be configured; automatically, the device 's clock is aligned with the PC's clock, in order to assure the temporal reference of the sample.

Sampling operations start may be selected disconnecting the USB cable or giving the proper command with the magnetic key (refer to [7 - Stand-alone USB datalogger installation.](#)). More details on device 's connection/disconnection through the USB cable are available on the [WineCap System - User Manual R31](#) manual.

c. On field transition from USB to Wireless datalogger:

This transition is practicable in field, during the sampling period, using the wireless network association command. When the association is done, the datalogger becomes a wireless datalogger and, besides sending new measures to the gateway, starts a download process towards the same gateway of the measures acquired during the stand-alone period (refer to [Picture 6 - Status table - Stand-alone mode](#)).

3. Sensor positioning.

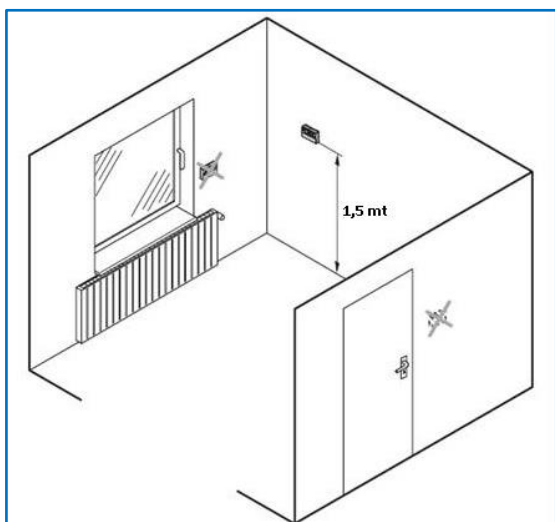

Picture 2 - Sensor positioning

To ensure that the measurements are not affected by external factors, some precautions must be taken into consideration during positioning:

- positioning must take place on a dividing wall, about 1.5 meters from the floor;
- the device must not be placed near doors and windows;
- the device must not be positioned above the radiators;
- the device must not be placed near heat sources;



4. Wireless device user interface.

The user interface consists of a “virtual” button that can be activated using the *WineCapKey* and of a two-colours led.

To give a command, user must approach the *WineCapKey* to the device's sensible area and keep it in that position.; the following picture (*Picture 3 - WineCapKey positioning*) shows device's sensible points.

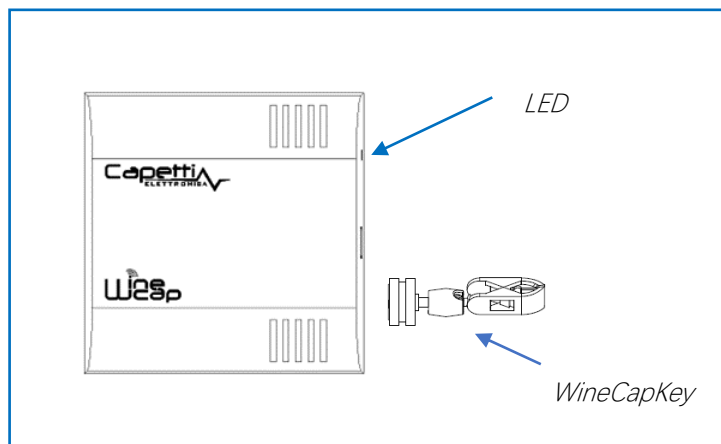







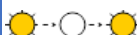

Picture 3 - WineCapKey positioning



The following COMMAND table describes the available commands:

WIRELESS DEVICES USER INTERFACE

Flash count	Command	Description
1 flash 	STATUS	Shows the device STATUS . As answer the led perform a flash sequence as reported in the STATUS table. If the device is performing the TEST (refer to <i>TEST command</i>) this command stops it.
2 flashes 	TEST	Enter in TEST mode and transmits status and measurements every 5 seconds. If the device is in STANDBY mode or it is out of radio range, this command forces the connection procedure to the WSN and the return to the operative mode. The TEST stops after 120 seconds. During TEST , the led continuously shows the STATUS to monitor the received radio signal quality. CAUTION: Measures acquired during TEST phase are NOT saved.
3 flashes 	ENROL	Association to the network: must be used when the device has not yet been included in a network, starts the entry and association procedure to the gateway (refer to <i>"WineCap System - User Manual R31"</i>).
4 flashes  + 4 flashes 	STANDBY	Temporary device deactivation: the device is stopped. The sampling process and the radio are/is. turned off losing the connection to the network. To reactivate, a TEST command is necessary. The STANDBY command must be given twice to confirm it: at the first sequence the led flashes alternating RED and GREEN lights, waiting for the second confirm sequence within 15 seconds. At the command execution the led flashes as the STANDBY status (refer to <i>"Picture 5 - Status table - Wireless mode"</i>).
5 flashes  + 5 flashes 	FACTORY RESET	The device performs the memory deleting procedure and goes in STOP status. All samples, configuration and wireless network data associated are LOST. To reactivate the device a new association and configuration procedure is necessary (<i>ENROL command</i>). Also in this case, the FACTORY RESET command must be given twice to confirm it. At the command execution the led flashes as the "PROBE/DATALOGGER NOT ASSOCIATED" status (refer to <i>"Picture 5 - Status table - Wireless mode"</i>).
5 flashes  + 3 flashes 	LOGGER NO WSN	As the previous command but performs only the WSN deleting procedure and disassociate from the gateway. The device enters in LOGGER STAND ALONE mode: data are kept, and the sampling activity CONTINUES with previous setup. Command must be given with 2 sequences: 5 flashes and then 3 flashes. At the command execution wait for the device reboot. At the STATUS command, "LOGGER" will be the answer (refer to <i>"Picture 6 - Status table - Stand-alone mode"</i>). A new association (<i>ENROL command</i>) is possible to a new gateway.

Picture 4 – Wireless devices user interface

5. Device enrolment.

Not necessary if performed in factory before delivery.

Enrol the device to the wireless network referring to the *"WineCap System - User Manual R31"*. In case the device is already enrolled but in **STANDBY** status, a **TEST** command must be issued (refer to *Picture 4 – Wireless devices user interface*).

6. Installation procedure.

After installing the gateway in appropriate place in charge, (refer to *"WineCap System - User Manual R31"*), be sure that the device is enrolled to the gateway and activated.

Head for the installation point. On the way, to check the quality of the radio coverage, use the "Field Measurer" function.

This function is activated issuing the **TEST** (refer to *Picture 4 – Wireless devices user interface*) command: position the *WineCapKey* in the spot indicated in *Picture 3 - WineCapKey positioning* and wait for two ORANGE flashes, then remove the *WineCapKey* from device. The "Field Measurer" function lasts enabled for two minutes.

To issue commands to the device, place the *WineCapKey* where indicated.

Once the *WineCapKey*, is detected, the led periodically emits ORANGE flashes with a 2 second cadence.



For each flash, a different command is associated; to confirm the command the *WineCapKey* must be removed from the sensible area immediately after the number of flashes corresponding at the desired command. The **TEST** corresponds to the second pulse and activate the "Field Measurer" function.

The device will give back the radio signal quality through led flashes:

WIRELESS MODE STATUS Table

FLASH COUNT – WIRELESS MODE		STATUS/RADIO SIGNAL QUALITY
	5 green flashes	ACTIVE - Radio signal: Excellent
	4 green flashes	ACTIVE - Radio signal: Good
	3 green flashes	ACTIVE - Radio signal: Fair
	2 ORANGE flashes	ACTIVE - Radio signal: Sufficient
	1 red flash	ACTIVE - Radio signal: Insufficient
	1 red flash 2" long	OUT OF RANGE Network searching
	2 red flashes 2" long	STANDBY Radio off - No Logging
	Short-long-short red flashes series	FACTORY RESET Device not enrolled – No logging

Picture 5 - Status table – Wireless mode

Optimize reception selecting the best position: small movements can help.

If the signal is absent or insufficient at the install point, a *repeater WR12* should be put between (refer to "*WineCap System - User Manual R31*"). The *repeater WR12* itself must be in a position where the signal level is at least sufficient.

The network will reconfigure itself automatically; the signal will be good again when the device synchronizes with the *repeater WR12*.

The wireless communication will not be reconfigured until completely lost by the device. Because of this, in some cases it could be necessary to force the operation. In such cases, put the device in **STANDBY** mode, then run the **TEST** again (refer to "*WineCap System - User Manual R31*").

NOTE: The display equipped datalogger (*WD04T*) is recommended, to verify the signal quality during devices installation.

7. Stand-alone USB datalogger installation.

Install the datalogger in appropriate place.

If the sampling process has not yet been activated, you can start it through the *WineCapKey*.

Bring it closer to the sensitive point, wait for 2 flashes (**TEST**) (refer to *Picture 4 – Wireless devices user interface*) and remove. The datalogger begins sampling according to your settings through your PC.

Through the *WineCapKey* is possible to ask for the status, bring it close to the datalogger for 1 flash (**STATUS**) and remove it.

STAND-ALONE DEVICE - STATUS TABLE

FLASH COUNT –STAND ALONE MODE		STATUS
	1 green flash 2 seconds long	ACTIVE
	2 red flashes 2 seconds long	STANDBY
	Sequence of red flashes: short, 2 seconds long, short	FACTORY RESET INVALID datalogger clock! PC connection required.

Picture 6 - Status table - Stand-alone mode



8. Shutting off/Reactivating the device.

If the device is shut off and left unused for a long time, you can issue the **STANDBY** command (refer to *Picture 4 – Wireless devices user interface*). It corresponds to the command number 4 and must be issued twice to confirm the operation.

Position the *WineCapKey* in the spot indicated in (*Picture 3 - WineCapKey positioning*), and wait for four ORANGE flashes, then remove the *WineCapKey* from device. Verify that the device asks for confirmation of **STANDBY** command with alternate GREEN/RED flashing, then position again the *WineCapKey* and wait for four flashes again. The device will confirm the **STANDBY** status lighting the RED led for 2 seconds twice. To reactivate the device the **TEST** command must be issued.

9. Transducer's connection layout.

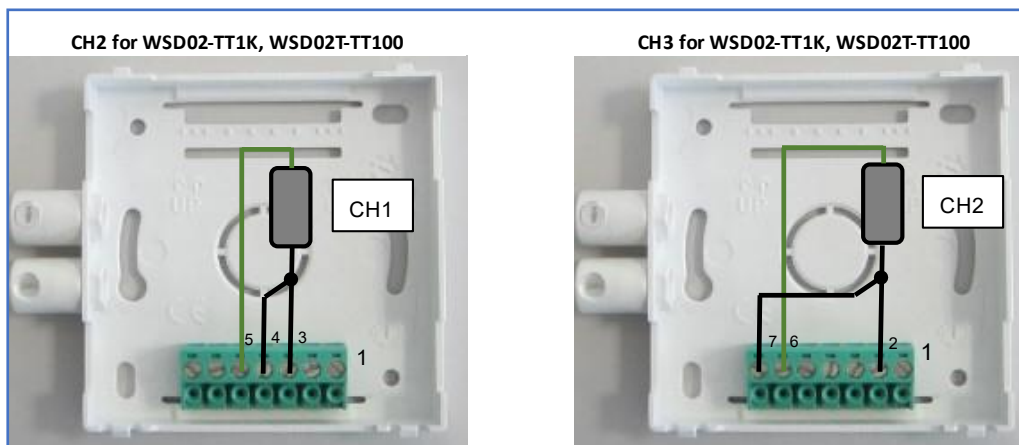

Picture 7 - Connections layout



10. Technical Information.

Power supply	2.4Ah - 3.6V type "AA" lithium internal battery (<i>BAT1</i>)
Battery life (*)	Up to 5 years (<i>samples every 10 minutes and radio signal quality at least sufficient</i>)
Measures acquired (<i>2 input channels</i>)	PT1000 transducer input
Sampling interval (*)	Selectable from one minute to 24 hours (<i>10 minutes default</i>)
Datalogger capacity	128,000 samples (<i>for each channel</i>)
Working temperature	<ul style="list-style-type: none"> Operative: -30°C ÷ +60°C Warehousing: -40°C ÷ +70°C
Radio frequency	ISM 868MHz
Radio coverage	Up to 6Km in line of sight (<i>can be extended using WR12 battery powered repeaters</i>)
Sealing	IP30
Dimensions	80x80x25mm
Weight	100g
Case material	ABS
Mounting	Fix on 2/4 points
Connections	Wireless USB
Cable external diameter	4.7mm maximum
Copper wire section	0.05 ÷ 2.5mm ² / ÷ 14 AWG
PT1000 input - Transducer type	Two and/or three wires PT1000
PT1000 input - Measure range	-200°C ÷ 125 °C
PT1000 input - Measure accuracy (<i>for the datalogger only</i>)***	± 0.3°C in the whole range
PT1000 input - Measure resolution	0.1°C

* battery life may be influenced by fieldwork conditions, sampling/measuring interval and system configuration.

** radio coverage can be extended using up to 32 WR12 repeaters (maximum 16 for each path) between the device and the gateway.

*** available also in special versions with better precision specifying, during order, the restricted measure range.



11. Mechanical dimensions.



Picture 8 - Mechanical dimensions

12. Disclaimer.

- Specifications are subject to change without notice and should not be interpreted as a commitment on the part of Capetti Elettronica S.r.l.
- Capetti Elettronica S.r.l. assumes no responsibility for possibly errors that may appear in this document. In no case Capetti Elettronica S.r.l. will be liable for incidental or consequential damages resulting from the use of this document or the systems described in this document.
- All Contents published or distributed by Capetti Elettronica S.r.l. are made available for general information purposes.
- It is not permitted to publish or use, in whole or in part, such contents for commercial purposes without the explicit written consent of Capetti Elettronica S.r.l.
- The reproduction, duplication, modification, sale or resale of this material or part of it is not permitted without the explicit written consent of Capetti Elettronica S.r.l.
- The product is not intended for use in applications where safety is critical, such as life-security systems or medical-related applications.
- If a channel is saturated or disrupted "Frequency hopping" transmitting method allows data integrity and security, but correct functioning of the product in environments with high radio activity is not guaranteed.



13. Reference standards.

EN 61010 -1

For electromagnetic compatibility

EN 61000 - 3 - 2

EN 61000 - 3 - 3

EN 300 220 -2

EN 301 489 - 03

EN 61000 - 6 -1

This symbol indicates that this product is compliant with the European Directive 2011/65/CE that restricts the use of substances in the manufacturing of electronic devices.



The "WEEE" logo on the label indicates that this product is compliant with the "WEEE" EC Directive. This symbol (valid only in the European Union countries) indicates that the product it is applied to, MUST NOT be discarded with ordinary household or industrial waste, but must be sent to an authorized reception point. The end user should contact the device provider, either the manufacturer or the reseller, to agree a collection and disposal process, after having checked the terms and conditions of sale.



IT1902000001116

