



## 1. Description.

The **WSD15TIIDR** is a **datalogger** with 3 input channels to acquire, Biaxial inclination, and Outdoor temperature, with storage functionality of samples acquired.



Picture 1 - Product Image

## 2. Configuration.

Printed on the external label, the correspondence between the measured axes and the number of recorded measure channels is reported, by means of the three icons below:

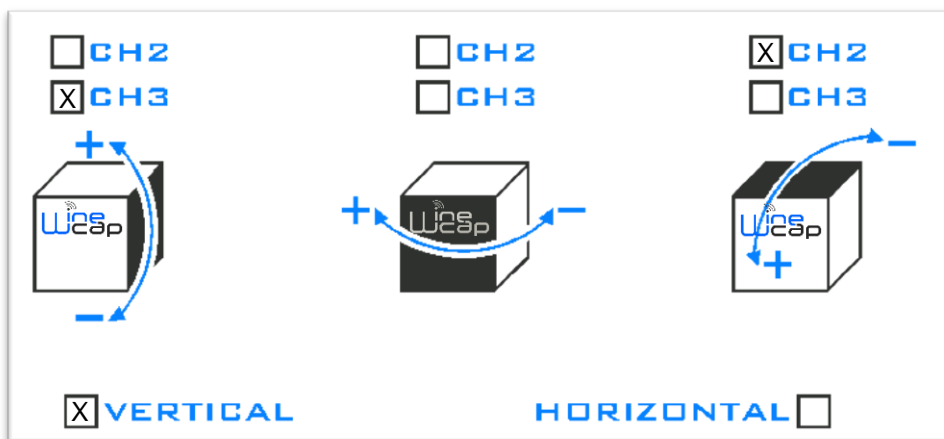

Picture 2 - WSD15TIIDR - Channels/axes correspondence



The front side of the cube corresponds to the labelled side, meanwhile the black one represents the side the drawn rotation refers to, including versus.

In [Picture 6 - Device positioning](#) the [WSD15TIIDR](#)'s CH2 measures tilt related to the horizontal axis parallel to the wall, positive in the frontal sense, meanwhile the CH3 is the side tilt around the axis normal to the surface, positive when measured counterclockwise.

Fix the [FIX-WSD15](#) support slab searching for the best vertical position.

Issuing *TEST* command, samples acquired can be forced to be sent to **basestation** for a quick check. (refer to [2.1 - "ELECTRONIC LEVEL" feature.](#))

Working on slab's regulation, sensor position can be corrected and the device can be placed as vertical as possible.

**NOTE:** antenna must be facing downwards.

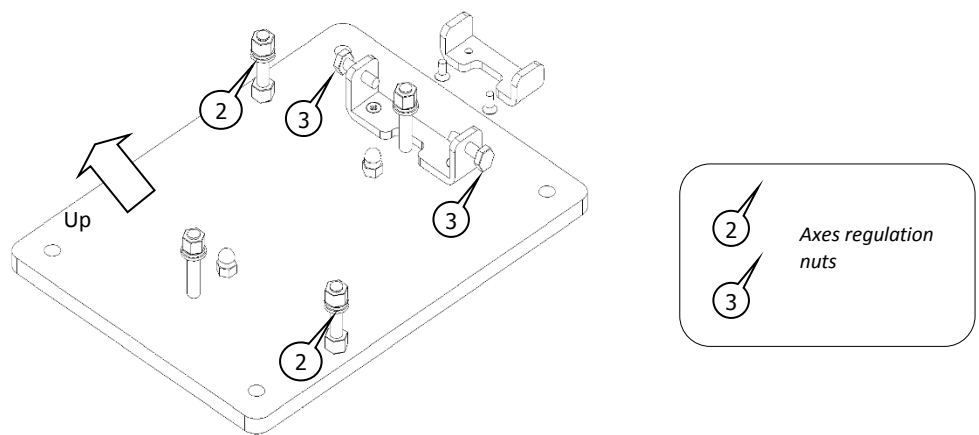

Picture 3 - FIX-WSD15 Micrometric regulation slab

### 2.1. "ELECTRONIC LEVEL" feature.

Activate the axis reset procedure for channel 2 placing the [WineCapKey](#) in the upper left corner and counting 6 amber flashes.

Led will flash based on the measured tilt.

*RED* flashes or *GREEN* flashes indicates an off-axis position in one of the two directions.

The flashing rate increases in proximity of the zero point.

Operating on fine tune screws, the zero point can be approached until alternate *RED* and *GREEN* flashes are shown. In this condition, the device is within a range of  $\pm 0.1^\circ$ .

The electronic level stops automatically after a 2 minutes timeout, or it can be stopped manually with the command 1.

Alternatively, repeat command 6 when the alignment has been reached, thus resetting the instrument to the current position (refer to [2.2 - "RESET READING" Feature](#)).

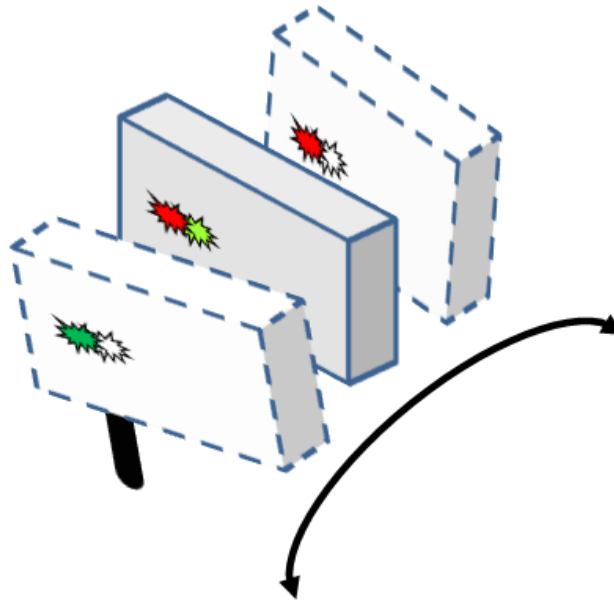

Picture 4 - "ELECTRONIC LEVEL" feature on CH2

## 2.2. "RESET READING" Feature

Issue command 6 twice in a row to activate the measure reset process.

The first command activates the ELECTRONIC LEVEL function, useful in order to improve the tool's position, meanwhile the second instance of the command stores the current position as initial offset.

In case of an unintentional reset, it is always possible to place again the tool near the mechanical zero (using "ELECTRONIC LEVEL" feature.), and repeat the reset process.

[WineCapManager](#) software shows and if necessary reset the offset stored in the **datalogger** using a remote radio command.

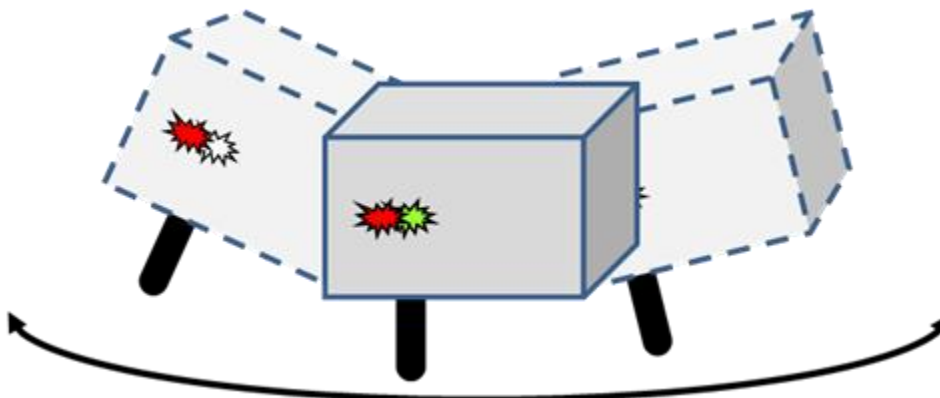

Picture 5 - "ELECTRONIC LEVEL" feature on CH3

ELECTRONIC LEVEL and RESET READING features are available and works the same for the second tilt channel (*channel 3*).

Issue command 7 to use these features on channel 3: the first time for the ELECTRONIC LEVEL, twice for RESET READING.



### 3. Device preset and use mode.

- **Wireless Mode:**

No setup operation is needed. Typically the system is configured from factory so the device is already associated to the system **basestation**. The device is in *STANDBY* mode (refer to [Picture 9 - Status table - Radio signal quality](#)) for which is necessary to start it with the *TEST* command (refer to [Installation procedure](#)).

Otherwise, in case the device is in *FACTORY RESET* mode (refer to [Picture 9 - Status table - Radio signal quality](#)), that means it's ready for connecting to an existing system, in order to associate it, make reference to the "[WineCap System - User Manual R29](#)" software manual. Is necessary to use the "[WineCapManager](#)" software on the PC connected to the **basestation** that will be coupled with the device.

- **USB Logger Mode:**

For this operation mode, stand-alone with data downloads through USB, the connection with the PC and the "[WineCapManager](#)" running on it is necessary in order to modify the device 's operation mode. The sampling interval must be set with the device in "*STAND-ALONE*" (refer to [Stand-alone USB datalogger installation](#).) mode and automatically, the device 's clock is aligned with the PC's clock, in order to assure the temporal reference of the sample.

Sampling operations start may be selected disconnecting the USB cable or giving the proper command with the magnetic key. (refer to [Stand-alone USB datalogger installation](#).). More details on device 's connection/disconnection through the USB cable are available on the [WineCap System - User Manual R29](#) manual.

- **On field transition from USB to Wireless datalogger:**

This transition is practicable in field, during the sampling period, using the wireless network association command. When the association is done, the **datalogger** becomes a wireless **datalogger** and, besides sending new measures to the **basestation**, starts a download process towards the same **basestation** of the measures acquired during the stand alone period (refer to [Picture 10 - Stand-alone datalogger status](#)).

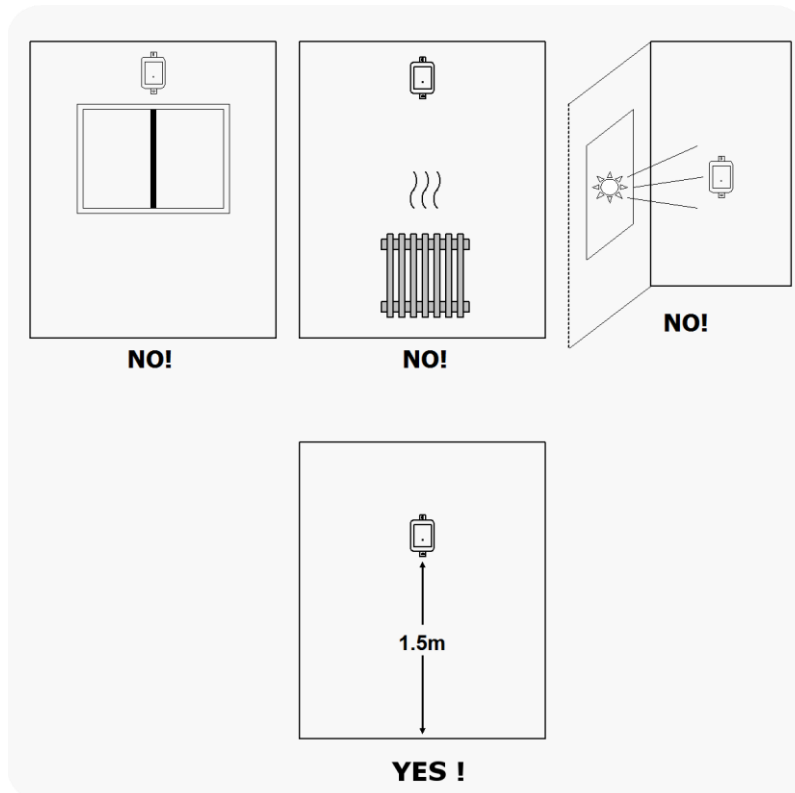

Picture 6 - Device positioning

**4. Wireless device user interface.**

The user interface consists of a “virtual” button that can be activated using the [WineCapKey](#) and of a two-coloured led.



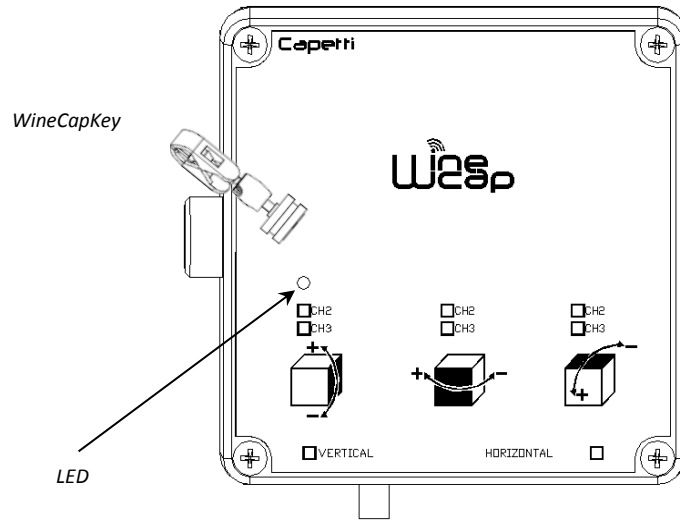



To give a command, user must approach the [WineCapKey](#) to the device’s sensible area and keep it in that position.; the following picture ([Picture 7 - WineCapKey positioning](#)) shows device’s sensible points.

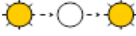

**Picture 7 - WineCapKey positioning**

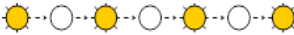
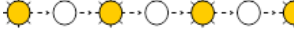

The following **COMMAND** table describes the available commands:

Flash count	Command	Description
1 flash 	<b>STATUS</b>	Shows the device STATUS. As answer the led perform a flash sequence as reported in the "STATUS" table. If the device is performing the TEST ( <i>refer to TEST command</i> ) this command stops it.
2 flashes 	<b>TEST</b>	Enter in TEST mode and transmits status and measurements every 5 seconds. If the device is in STANDBY mode or it is out of radio range, this command forces the connection procedure to the WSN and the return to the operative mode. The TEST stops after 120 seconds. During TEST the led continuously shows the STATUS to monitor the received radio signal quality. <b>CAUTION: Measures acquired during TEST phase are NOT saved.</b>
3 flashes 	<b>ENROLL</b>	Association to the network: must be used when the device has not yet been included in a network, starts the entry and association procedure to the <b>basestation</b> ( <i>refer to "WineCap System - User Manual R29"</i> ).
4 flashes  + 4 flashes 	<b>STANDBY</b>	Temporary device deactivation: the device is stopped. The sampling process and the radio are/is turned off losing the connection to the network. To reactivate, a TEST command is necessary. The STANDBY command must be given twice to confirm it: at the first sequence the led flashes alternating RED and GREEN lights, waiting for the second confirm sequence within 15 seconds. At the command execution the led flashes as the STANDBY status ( <i>refer to "WIRELESS MODE STATUS Table"</i> ).
5 flashes  + 5 flashes 	<b>FACTORY RESET</b>	The device performs the memory deleting procedure and goes in STOP status. All samples, configuration and wireless network data associated are LOST. To reactivate the device a new association and configuration procedure is necessary ( <i>ENROLL command</i> ). Also in this case, the FACTORY RESET command must be given twice to confirm it. At the command execution the led flashes as the "PROBE/DATALOGGER NOT ASSOCIATED" status <i>refer to "WIRELESS MODE STATUS Table"</i> .
5 flashes  + 3 flashes 	<b>LOGGER NO WSN</b>	As the previous command but performs only the WSN deleting procedure and disassociate from the <b>basestation</b> . The device enter in <b>LOGGER STAND ALONE</b> mode: data are kept and the sampling activity CONTINUES with previous setup. Command must be given with 2 sequences: 5 flashes and then 3 flashes. At the command execution wait for the device reboot. At the STATUS command, "LOGGER" will be the answer ( <i>refer to "STAND-ALONE MODE STATUS Table"</i> ). A new association ( <i>ENROLL command</i> ) is possible to a new <b>basestation</b> .

Picture 8 - Commands table



## 5. Enrolling the device.

Not necessary if performed in factory before delivery.

Enroll the device to the network referring to the "[WineCap System - User Manual R29](#)". In case the device is already enrolled but in *STANDBY* status, a *TEST* command must be issued (refer to [Picture 8 - Commands table](#)).

## 6. Installation procedure.

After installing the **basestation** in appropriate place in charge, (refer to "[WineCap System - User Manual R29](#)"), be sure that the device is enrolled to the **basestation** and activated.

Head for the environment to be monitored. On the way, to check the quality of the radio coverage, use the "*Field Measurer*" function.

This function is activated issuing the *TEST* (refer to [Picture 8 - Commands table](#)) command: position the [WineCapKey](#) in the spot indicated in [Picture 7 - WineCapKey positioning](#) and wait for two *AMBER* flashes, then remove the [WineCapKey](#) from device. The "*Field Measurer*" function lasts enabled for two minutes.







To issue commands to the device, place the [WineCapKey](#) where indicated.

Once the [WineCapKey](#) is detected, the led periodically emits *AMBER* flashes with a 2 seconds cadence.

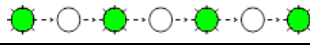
For each flash, a different command is associated; to confirm the command the [WineCapKey](#) must be removed from the sensible area immediately after the number of flashes corresponding at the desired command. The *TEST* corresponds to the second pulse and activate the "*Field Measurer*" function.

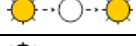
The device will give back the radio signal quality through led flashes:

WIRELESS MODE STATUS Table

Flash count - Wireless mode	Status/Radio signal quality
 5 green flashes	Excellent
 4 green flashes	Good
 3 green flashes	Fair
 2 amber flashes	Sufficient
 1 red flash	Insufficient
 1 red flash 2" long	OUT OF RANGE Network searching
 2 red flashes 2" long	STANDBY
 Short-long-short red flashes series	FACTORY RESET Device not enrolled

Picture 9 - Status table - Radio signal quality

Optimize reception selecting the best position: small movements can help.

If the signal is absent or insufficient at the install point, a [WR12 router](#) should be put between (refer to "[WineCap System - User Manual R29](#)"). The [WR12 router](#) itself must be located in a position where the signal level is at least sufficient.

The network will reconfigure itself automatically; the signal will be good again when the device synchronizes with the [WR12 router](#).

The link will not be reconfigured until completely lost by the device. Because of this, in some cases it could be necessary to force the operation. In such cases, put the device in *STANDBY* mode, then run the *TEST* again (refer to "[WineCap System - User Manual R29](#)").

**NOTE:** The display equipped **datalogger** ([WD04T](#)) is recommended, to verify the signal quality during devices installation.



## 7. Stand-alone USB datalogger installation.



Install the **datalogger** in appropriate place.

If the sampling process has not yet been activated you can start it through the [WineCapKey](#).

Bring it closer to the sensitive point, wait for 2 flashes (**TEST**) (refer to [Picture 8 - Commands table](#)) and remove. The **datalogger** begins sampling according to your settings through your PC.

Through the [WineCapKey](#) is possible to ask for the current status, bring it close to the **datalogger** for 1 flash (**STATE**) and remove it.

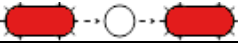
**STAND-ALONE MODE STATUS** Table:

Flash count - Stand-alone mode	STATUS
 1 green flash 2 seconds long	ACTIVE
 2 red flashes 2 seconds long	STANDBY
 Sequence of red flashes: short, 2 seconds long, short	FACTORY RESET <b>INVALID datalogger</b> clock! PC connection required

Picture 10 - Stand-alone datalogger status

## 8. Shutting off/Reactivating the device.

If the device is shut off and left unused for a long time, you can issue the **STANDBY** command (refer to [Picture 8 - Commands table](#)). Its corresponds to the command number 4 and must be issued twice to confirm the operation.

Position the [WineCapKey](#) in the spot indicated in [Picture 7 - WineCapKey positioning](#) and wait for four **AMBER** flashes, then remove the [WineCapKey](#) from device.

Verify that the device asks for confirmation of **STANDBY** command with alternate **GREEN/RED** flashing, then position again the [WineCapKey](#) and wait for four flashes again. The device will confirm the **STANDBY** status lighting the **RED** led for 2 seconds twice.

To reactivate the device the **TEST** command must be issued.



## 9. Technical Information.

Power supply	8.5A/h - 3.6V type "C" lithium internal battery
Battery life (*)	Up to 5years <i>(samples every 60 minutes and radio signal quality at least sufficient)</i>
Measures acquired (3 input channels)	<ul style="list-style-type: none"> <li>• Biaxial inclination</li> <li>• Outdoor temperature</li> </ul>
Sampling interval (*)	Selectable from one minute to 24 hours (60 minutes default)
Datalogger capacity	64,000 sample (for each channel)
Working temperature	<ul style="list-style-type: none"> <li>• Operative: -30°C ÷ +60°C</li> <li>• Warehousing: -40°C ÷ +70°C</li> </ul>
Radio frequency	ISM 868MHz
Radio coverage 	Up to 6Km in line of sight <i>(can be extended using <a href="#">WR12</a> battery powered routers)</i>
Sealing	IP67
Dimensions	100x100x80mm
Weight	1,6000g
Case material	Aluminium
Mounting	Wall mounting with ±2° gross setting
Connections	Wireless, USB
Inclination - Transducer type	Uniaxial/Biaxial/Triaxial - MEMS technology - 1°±15° Dual Range Automatic Autoscale
Inclination - Measure range	±1°/±15°
Inclination - Measure accuracy	± 0.5% of sample
Inclination - Measure resolution	0.001° (±1° range) - 0.01° (±15° range)
Inclination - Mechanical zero adjustment	±4°
Inclination - Cross-axis sensitivity	4% maximum
Inclination - Temperature variation sensibility	±0.013%/°C Temperature balance
Inclination - Shock resistance	20,000g
Inclination - Measure axis	Abscissa
Outdoor temperature - Transducer type	NTC10KΩ
Outdoor temperature - Measure range	-30°C ÷ +60°C
Outdoor temperature - Measure accuracy	<ul style="list-style-type: none"> <li>• ± 0.5°C Range -30°C ÷ 0°C</li> <li>• ± 0.2°C Range 0°C ÷ +60°C</li> </ul>
Outdoor temperature - Measure resolution	0.01°C

\* battery life may be influenced by fieldwork conditions, sampling interval and system configuration.

\*\* radio coverage reachable using up to 32 [WR12 routers](#) (maximum 16 for each path) between the device and the basestation.

10. Mechanical dimensions.

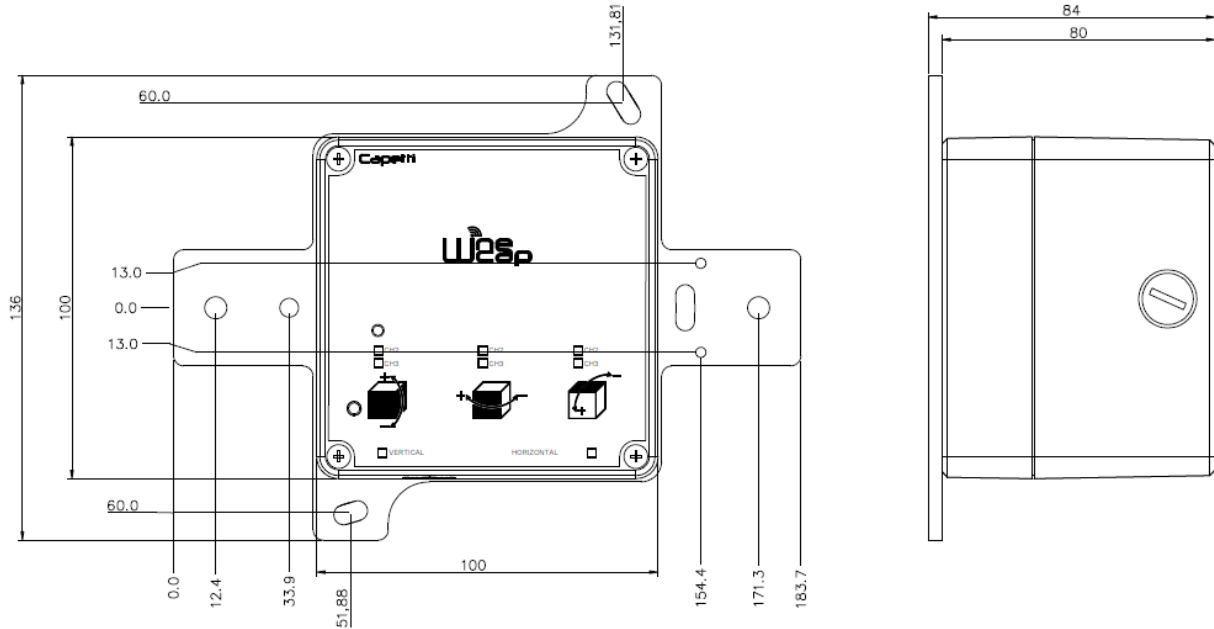

Picture 11 - Mechanical dimensions



---

## 11. Reference standards.

EN 61010 -1

For electromagnetic compatibility

EN 61000 - 3 - 2

EN 61000 - 3 - 3

EN 300 220 -2

EN 301 489 - 03

EN 61000 - 6 -1

---

This symbol indicates that this product is compliant with the European Directive 2011/65/CE that restricts the use of substances in the manufacturing of electronic devices.



---

The "WEEE" logo on the label indicates that this product is compliant with the "WEEE" EC Directive. This symbol (valid only in the European Union countries) indicates that the product it is applied to, MUST NOT be discarded with ordinary household or industrial waste, but must be sent to an authorized reception point. The end user should contact the device provider, either the manufacturer or the reseller, in order to agree a collection and disposal process, after having checked the terms and conditions of sale.



IT190200000111

---

*The features shown may be subject to change without notice.*

